

13790510059

5

4

3

2

1

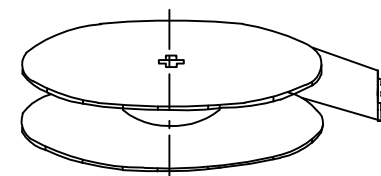
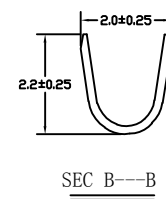
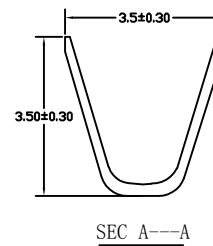
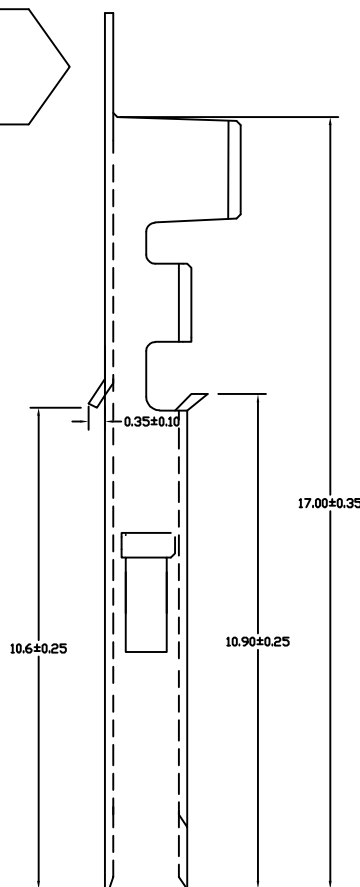
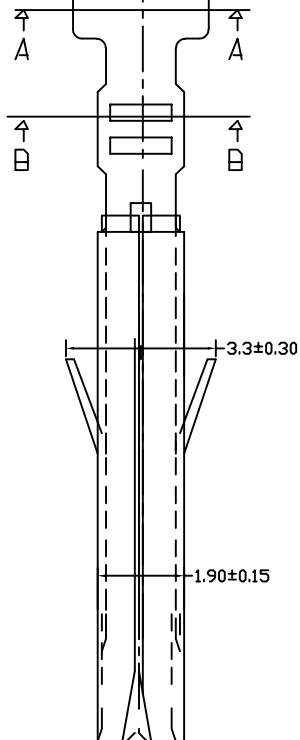
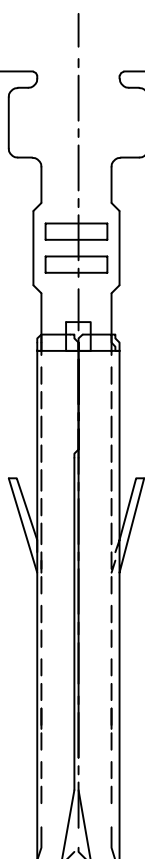
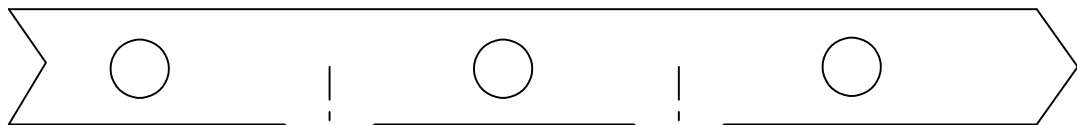

电镀后收料方向

ESTK15800 T P X - 2 X - X

↑ 普通代码+间距
↑ T 示意端子
↑ X 普通脚
↑ H 高脚
↑ X 普通
↑ L 长
↑ S 短
↑ U 超薄
X 公端
G 母端
C 示意90°
S 示意180°

P 磷铜
B 黄铜
E 合金铜
0 素材
2 镀锡先冲后镀
3 镀锡先镀后冲
4 镀金(镀后冲)
4.2 镀全镍先冲后镀
5G、15G 示意镀金5U*或15U*、1G 示意镀金1U*

■ SPECIFICATIONS

- Voltage rating: 250V AC/DC;
- Current rating: 3A AC/DC;
- Withstanding Voltage: 1500V AC/minute
- Working Temperature: -25°C~+85°C
- Contact resistance: 30mΩ Max
- Applicable wire: AWG#18~#22

日期版次 REVISION	日期 DATE	变更内容 DESCRIPTION	核 准 APPROVALBY



东莞市羿通实业有限公司
DONGGUAN EASTOM ELECTRONIC Co., Ltd.

料号PART NO: ESTK15800TPX-2X-G

品名 TITLE: 1.58-T(母)

材料: 单位: MM 包装规格: 比例: 1:1

制图: 审核: 核准: 日期: 2022. 4. 22

一般公差
GENERAL TOLERANCE
X.X ±0.25
X.XX ±0.20
ANGLE ±1°

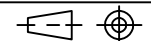

EST