

13790510059

5

4

3

2

1

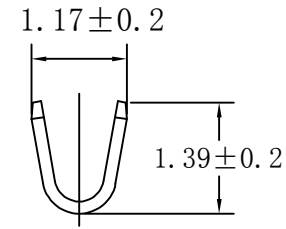
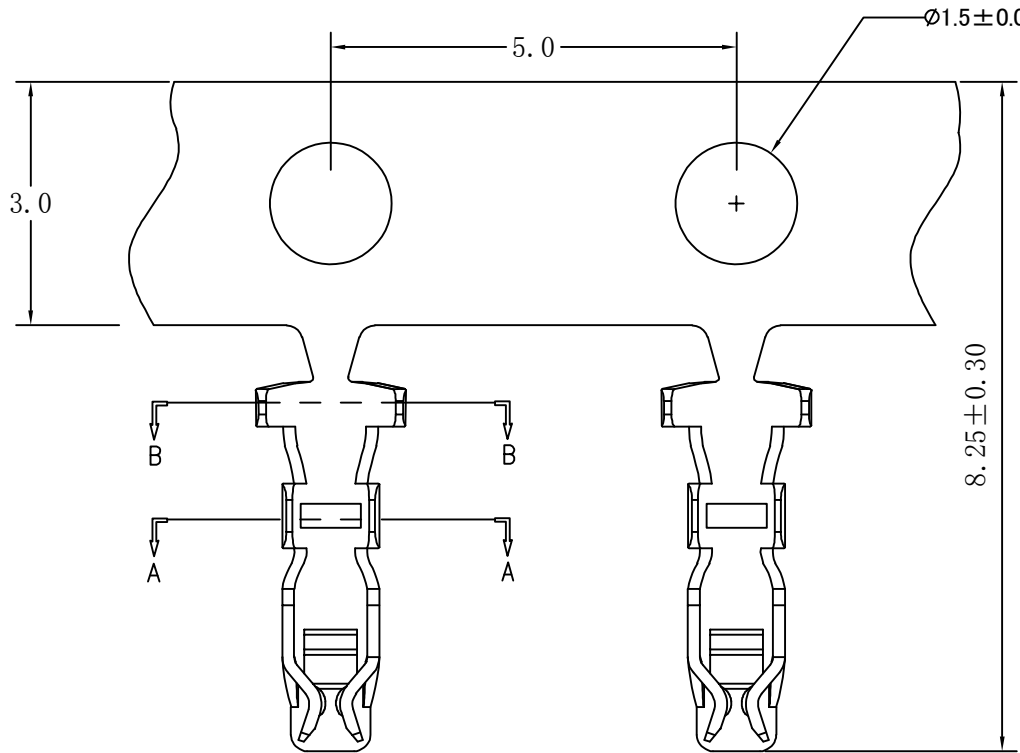

SECTION A-A

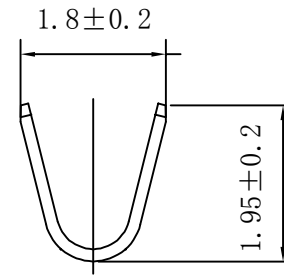

SECTION B-B

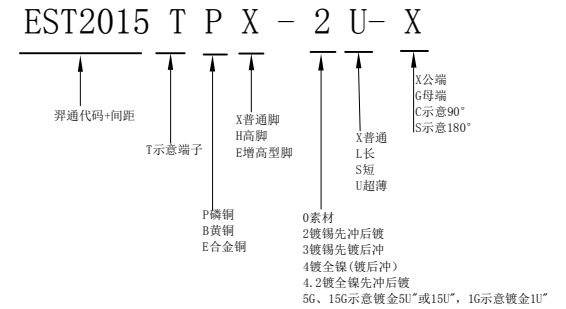
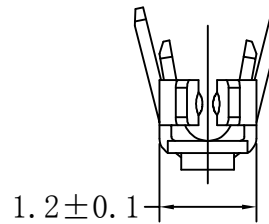
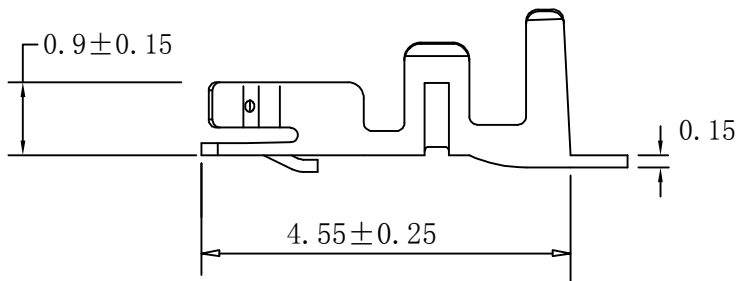

■ SPECIFICATIONS

- Voltage rating: 250V AC/DC;
- Current rating: 2A AC/DC;
- Withstanding Voltage: 500V AC/minute
- Insulation resistance: 500MΩ Min
- Temperature range: -25°C ~ +85°C
- Contact resistance: 20mΩ Max

日期版次 REVISION	日期 DATE	变更内容 DESCRIPTION	核 准 APPROVAL BY



东莞市羿通实业有限公司
DONGGUAN EASTOM ELECTRONIC Co., Ltd.

料号PART NO: EST2015TPX-2U-G

品名 TITLE: MX2.0-T(超薄)

材料:	单位: MM	包装规格:	比例: 1:1
制图:	审核:	核准:	日期: 2022.6.21

一般公差
GENERAL TOLERANCE
X.X ±0.30
X.XX ±0.25
ANGLE ±1°

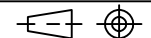

0.2*17*10

5

4

3

2

1

EST