

13790510059

5

4

3

2

1

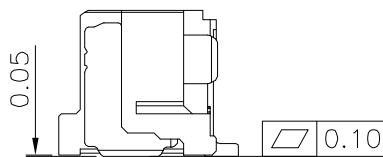
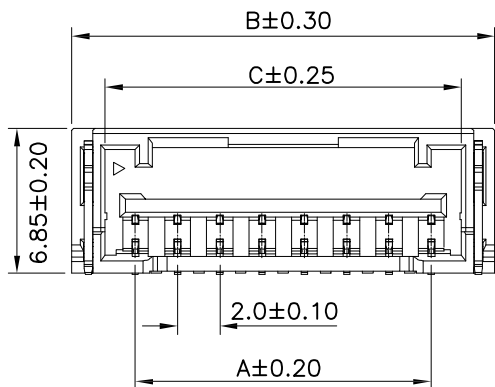
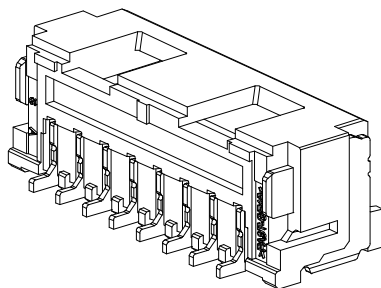
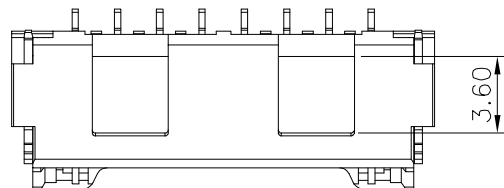

EST2024 W RS - 1*NP X - X X - X X - NK-HF

↑ 零件代号-顺序
 ↑ PIN数
 ↑ X本色
 ↑ B黑色
 ↑ R红色
 ↑ L蓝色
 ↑ Y黄色
 ↑ G绿色
 ↑ 1单排
 ↑ 2双排
 ↑ X普通
 ↑ B带扣
 ↑ L超薄
 ↑ PH组合排针
 ↑ PH组合排母
 ↑ 折弯
 ↑ D防呆型
 ↑ 2示意有柱
 ↑ 3示意无柱
 ↑ G为PIN针镀金
 ↑ S为PIN针镀锡
 ↑ 1为PFS, 2为PBT, 3为LCP, 4为ABS, 5为PBT, 6为PAB6
 ↑ NK为NO MARK
 ↑ MK为有MARK
 ↑ HF无卤
 ↑ NF普通含卤

V示意180°直针, VS立式
 R示意90°弯针, RS卧式

W示意针座
 W后无0默认材质为Y0
 W后带2示意Y2

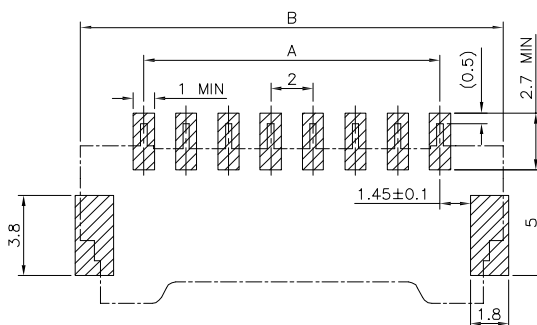
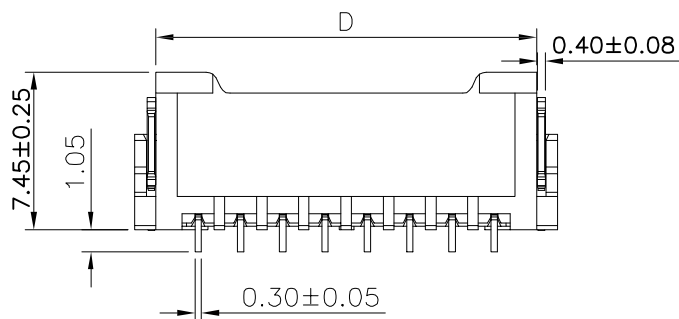

Recommended P.C.B LAYOUT
 General Tolerance±0.05

Poles	Dimensions (mm)				Poles	Dimensions (mm)			
	A	B	C	D		A	B	C	D
02	2.00	8.00	4.85	6.00	09	16.00	22.00	18.85	20.00
03	4.00	10.00	6.85	8.00	10	18.00	24.00	20.85	22.00
04	6.00	12.00	8.85	10.00	11	20.00	26.00	22.85	24.00
05	8.00	14.00	10.85	12.00	12	22.00	28.00	24.85	26.00
06	10.00	16.00	12.85	14.00	13	24.00	30.00	26.85	28.00
07	12.00	18.00	14.85	16.00	14	26.00	32.00	28.85	30.00
08	14.00	20.00	16.85	18.00	15	28.00	34.00	30.85	32.00

SPECIFICATIONS

- Voltage rating: 250V AC/DC;
- Current rating: 3A AC/DC;
- Withstanding Voltage: 800V AC/minute
- Insulation resistance: 1000MΩ Min
- Temperature range: -25°C ~ +85°C
- Contact resistance: 20mΩ Max



东莞市羿通实业有限公司
 DONGGUAN EASTOM ELECTRONIC Co., Ltd.

料号PART NO: EST2024RS-1*NPX-X

品名 TITLE: 2024-Wafer (卧贴)

材料: 单位: MM 包装规格: 比例: 1:1
 制图: 审核: 核准: 日期: 2022. 6. 23

一般公差
 GENERAL TOLERANCE
 X. X ±0.25
 X. XX ±0.20
 ANGLE ±1°

日期版次 REVISION	日期 DATE	变更内容 DESCRIPTION	核 准 APPROVALBY

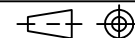

SL