

13790510059

5

4

3

2

1

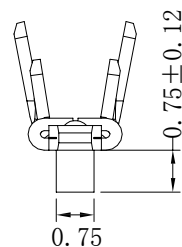
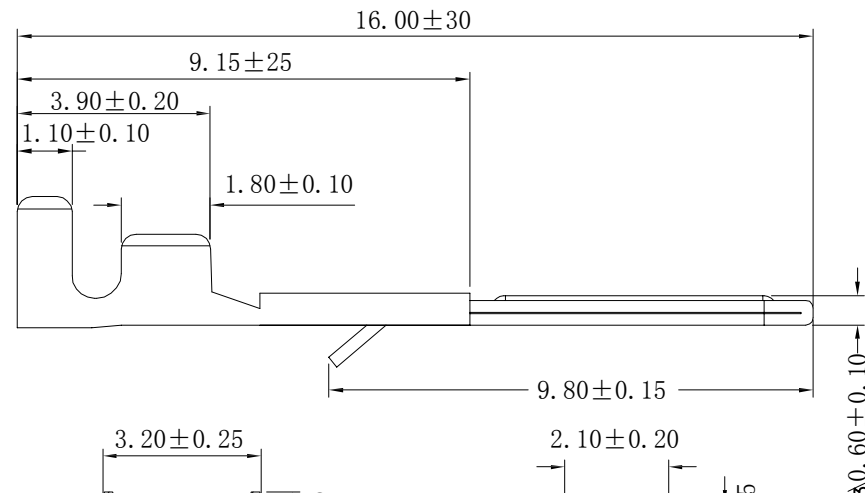
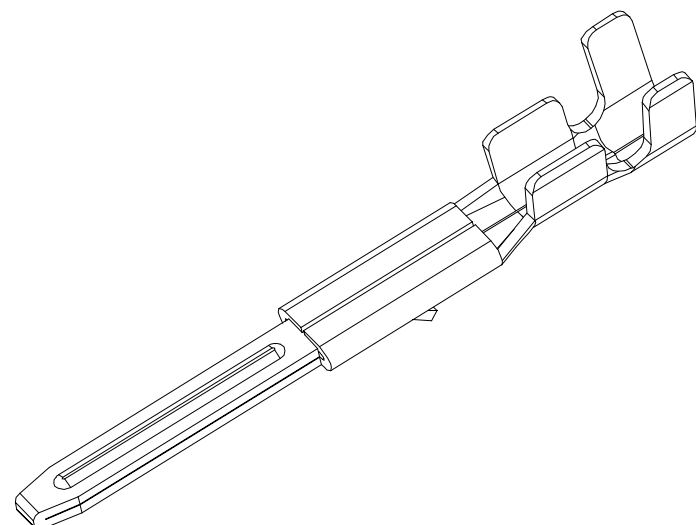
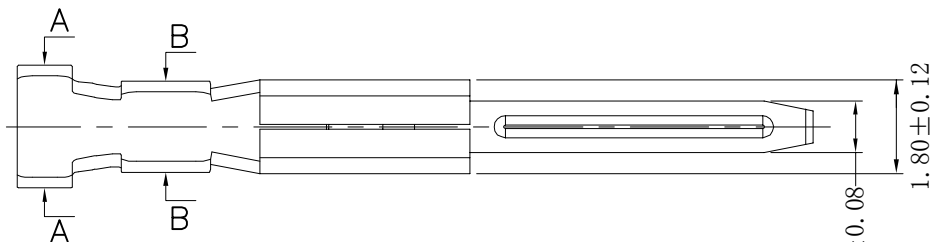

EST2507 T P X - 2 X- X

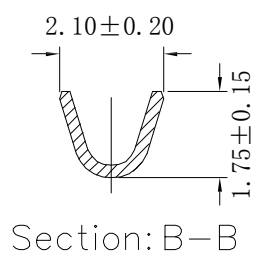
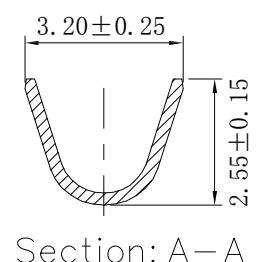
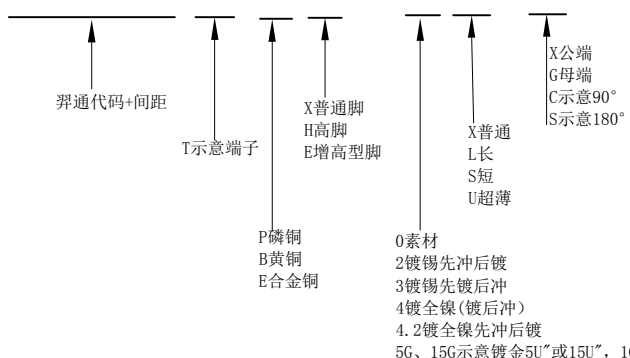

- SPECIFICATIONS**
- Voltage rating: 250V AC/DC;
 - Current rating: 3A AC/DC;
 - Withstanding Voltage: 1500V AC/minute
 - Insulation resistance: 500MΩ Min
 - Temperature range: -25°C ~ +85°C
 - Contact resistance: 10mΩ Max

日期版次 REVISION	日期 DATE	变更内容 DESCRIPTION	核 准 APPROVAL BY

东莞市羿通实业有限公司
DONGGUAN EASTOM ELECTRONIC Co., Ltd.

料号 PART NO: EST2507TPX-2X-X				一般公差 GENERAL TOLERANCE X.X ±0.30 X.XX ±0.25 ANGLE ±1°
品名 TITLE: SM2.5-T公				
材料:	单位: MM	包装规格:	比例: 1:1	
制图:	审核:	核准:	日期: 2022/7/2	

6

5

4

3

2

1

YL