

13790510059

5

4

3

2

F

F

E

E

D

D

C

C

B

B

A

A

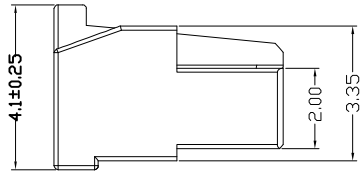
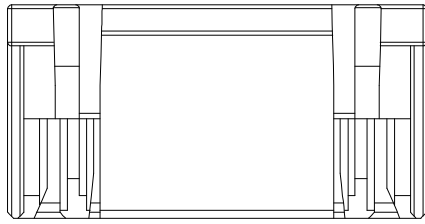
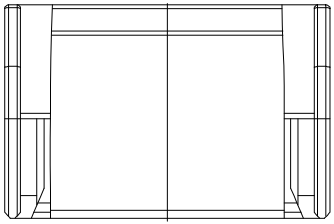

EST1256 H - 1\*NP X - B - X - HF-NK - X

- ↑ 羿通代码+间距
- ↑ PIN数  
1示意单排  
2示意双排
- ↑ X 普通  
B 带扣  
C 刺破  
R 红色  
L 蓝色  
Y 黄色  
G 绿色  
C 透明
- ↑ X 公胶壳  
G 母胶壳
- ↑ NO MARK
- ↑ HF 示意无卤  
NF 普通含卤
- ↑ A 灼热丝750  
B 灼热丝850  
X 普通料
- H 示意胶壳,  
H后无数字默认材质V0  
H后带数字2示意材质V2

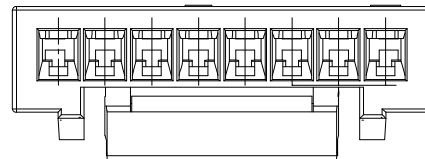
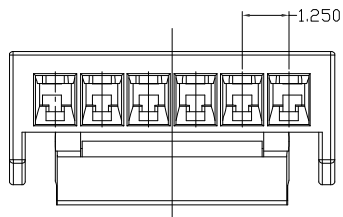
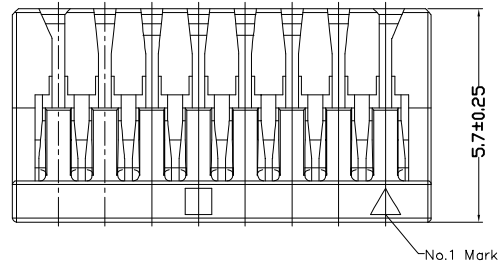
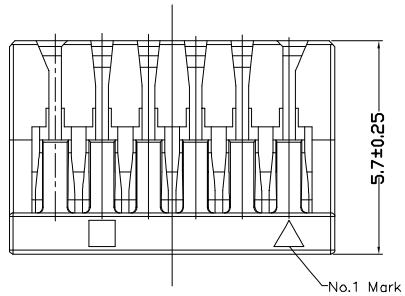
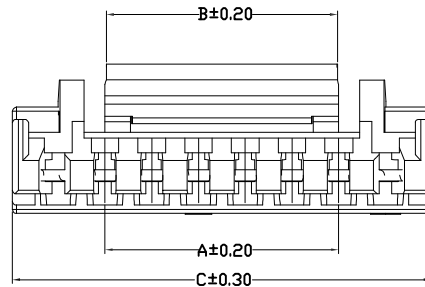
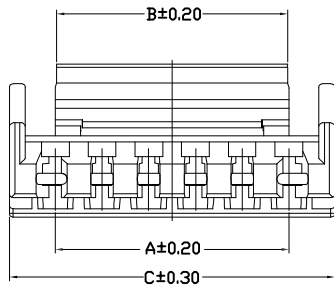
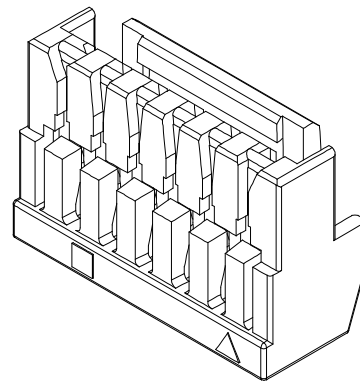

2-7P

8-16P

1.25mm Pitch wire to board connectors  
 Votage rating:50V AC/DC  
 Current rating:1A AC/DC  
 Withstanding Voltage:500V AC/minute  
 Insulation resistance:100M  
 Temperature range:-25°C~+85°C  
 Contact resistance:30mΩ Max

poles:2-16  
 Material:pa66  
 Q'ty:1000PCS/Bag

POLES	DIMENSION (mm)		
	A	B	C
2	1.25	2.20	3.75
3	2.50	3.20	5.00
4	3.75	4.25	6.25
5	5.00	4.25	7.50
6	6.25	6.25	8.75
7	7.50	6.25	10.00
8	8.75	6.25	11.25
9	10.00	6.25	12.50
10	11.25	8.20	13.75
11	12.50	8.20	15.00
12	13.75	8.20	16.25
13	15.00	8.20	17.50
14	16.25	8.20	18.75
15	17.50	8.20	20.00
16	18.75	8.20	21.25



东莞市羿通实业有限公司  
 DONGGUAN EASTOM ELECTRONIC Co., Ltd.

料号PART NO:EST1256H-1\*NPX-B

品名 TITLE: GH1.25-H

材料: C5191    单位: MM    包装规格:    比例: 1:1

日期版次 REVISION    日期 DATE    变更内容 DESCRIPTION    核 准 APPROVALBY    制图:    审核:    核准:    日期: 2022.4.17

一般公差 GENERAL TOLERANCE	
X.X	±0.30
X.XX	±0.25
X.XX	±0.10
ANGLE	±1°

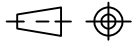

6

5

4

3

2

1