

13790510059

5

4

3

2

1

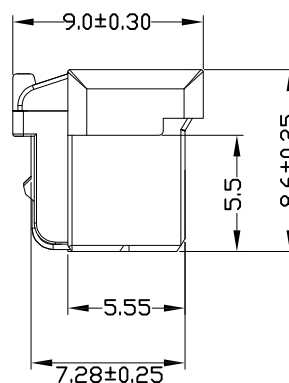
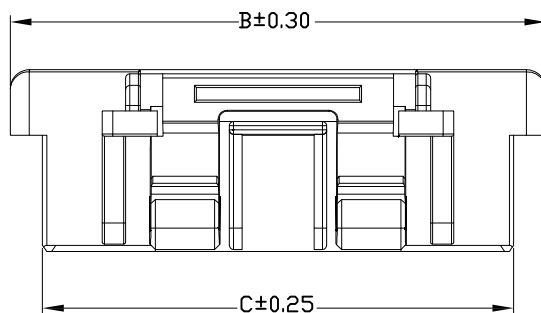
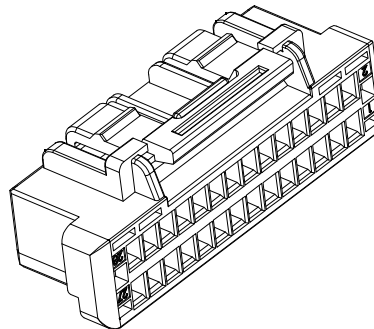
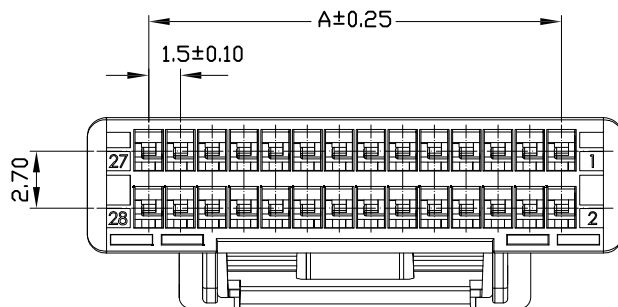

2*06P-2*15P Shape
Sale:1:1

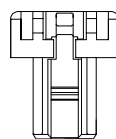
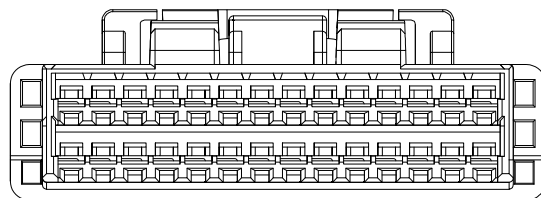

2*02P-2*03P Shape
Sale:1:0.7

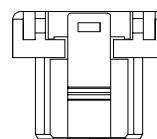

2*04P-2*05P Shape
Sale:1:0.7

EST1504 H - 1*NP X - B - X - HF-NK - X

↑ 羿通代码+间距 ↑ PIN数 ↑ X普通 ↑ X公胶壳 ↑ NO MARK ↑ A灼热丝750
 ↑ B带扣 ↑ C刺破 ↑ B黑色 ↑ G母胶壳 ↑ ↑ B灼热丝850
 ↑ 2L示意两侧带锁扣 ↑ U超薄F防呆型 ↑ R红色 ↑ HV带高凸点 ↑ HF示意无齿 ↑ X普通料
 ↑ L蓝色 ↑ LC带低凸点 ↑ Y黄色 ↑ K卡槽 ↑ NP普通含齿
 ↑ G绿色 ↑ E有耳 ↑ C透明 ↑ NE无耳

H示意胶壳,
H后无数字默认材质V0
H后带数字2示意材质V2

Poles	Dimensions (mm)			Poles	Dimensions (mm)		
	A	B	C		A	B	C
2*02	1.50	7.30	4.25	2*09	12.00	17.80	14.75
2*03	3.00	8.80	5.75	2*10	13.50	19.30	16.25
2*04	4.50	10.30	7.25	2*11	15.00	20.80	17.75
2*05	6.00	11.80	8.75	2*12	16.50	22.30	19.25
2*06	7.50	13.30	10.25	2*13	18.00	23.80	20.75
2*07	9.00	14.80	11.75	2*14	19.50	25.30	22.25
2*08	10.50	16.30	13.25	2*15	21.00	26.80	23.75

■ SPECIFICATIONS

- Voltage rating:100V AC/DC;
- Current rating:2A AC/DC;
- Withstanding Voltage:500V AC/minute
- Insulation resistance:500MΩ Min
- Temperature range:-40℃~+85℃
- Contact resistance:20mΩ Max
- Material:PBT
- After environmental testing:40 mΩ Max
- Wire range:#24~#28
- Insulation O. D.: 1.28mm Max



东莞市羿通实业有限公司
DONGGUAN EASTOM ELECTRONIC Co., Ltd.

料号PART NO: EST1504H-1*NPX-B-X

品名 TITLE: 1504-H

材料: 单位: MM 包装规格: 比例: 1:1

制图: 审核: 核准: 日期: 2022. 4. 20

一般公差
GENERAL TOLERANCE
X.X ±0.25
X.XX ±0.20
ANGLE ±1°

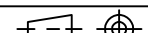

日期版次 REVISION	日期 DATE	变更内容 DESCRIPTION	核 准 APPROVALBY

6

5

4

3

2

1

SL